

B	CEID - Modification suivant remarques	28/10/2019	GB	RC	
A	CEID - Première diffusion	08/10/2019	GB	LC	
INDICE	MODIFICATION	DATE	DESSINE	VERIFIE	APPROUVE



194 ZA DE REMOULON
38 780 PONT-EVEQUE

N° TEL: 04 74 57 68 87
N° FAX: 04 74 57 68 92
DESSINE: G.BOUCHUT
VERIFIE: L.CHRISTOPHLE
DATE DE CREATION: 01/10/2019
AFFAIRE N°: 7200

SADE

RUE PIERRE DUPONT
69 741 GENAS

BATIMENT UFT

Schéma électrique

Page de garde

DOCUMENT N° : **7200-010**

1 / 10

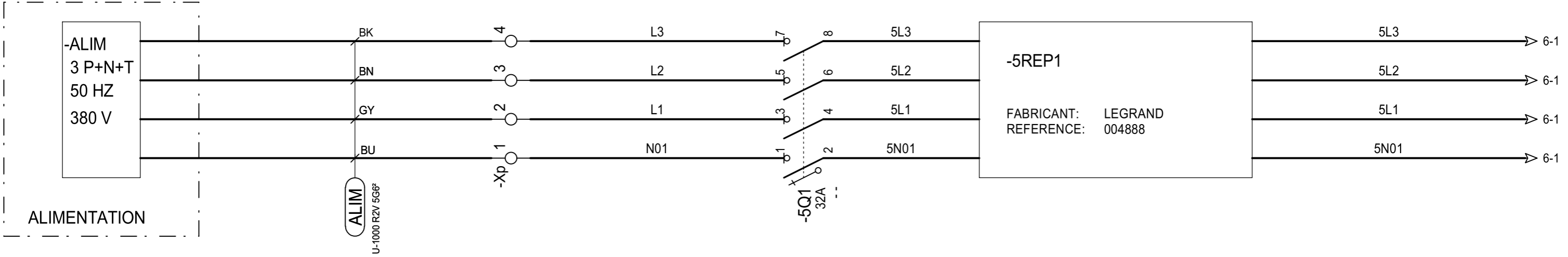

=
+ A1

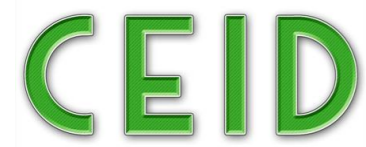

DESSINE :	G. BOUCHUT				
VERIFIE :	L. CHRISTOPHLE				
DATE DE CREATION :	01/10/2019	A	08/10/2019	CEID - Première diffusion	GB
		INDICE	DATE	MODIFICATION	DES.

SADE

Document n° : **7200-010**

BATIMENT UFT
Alimentation générale

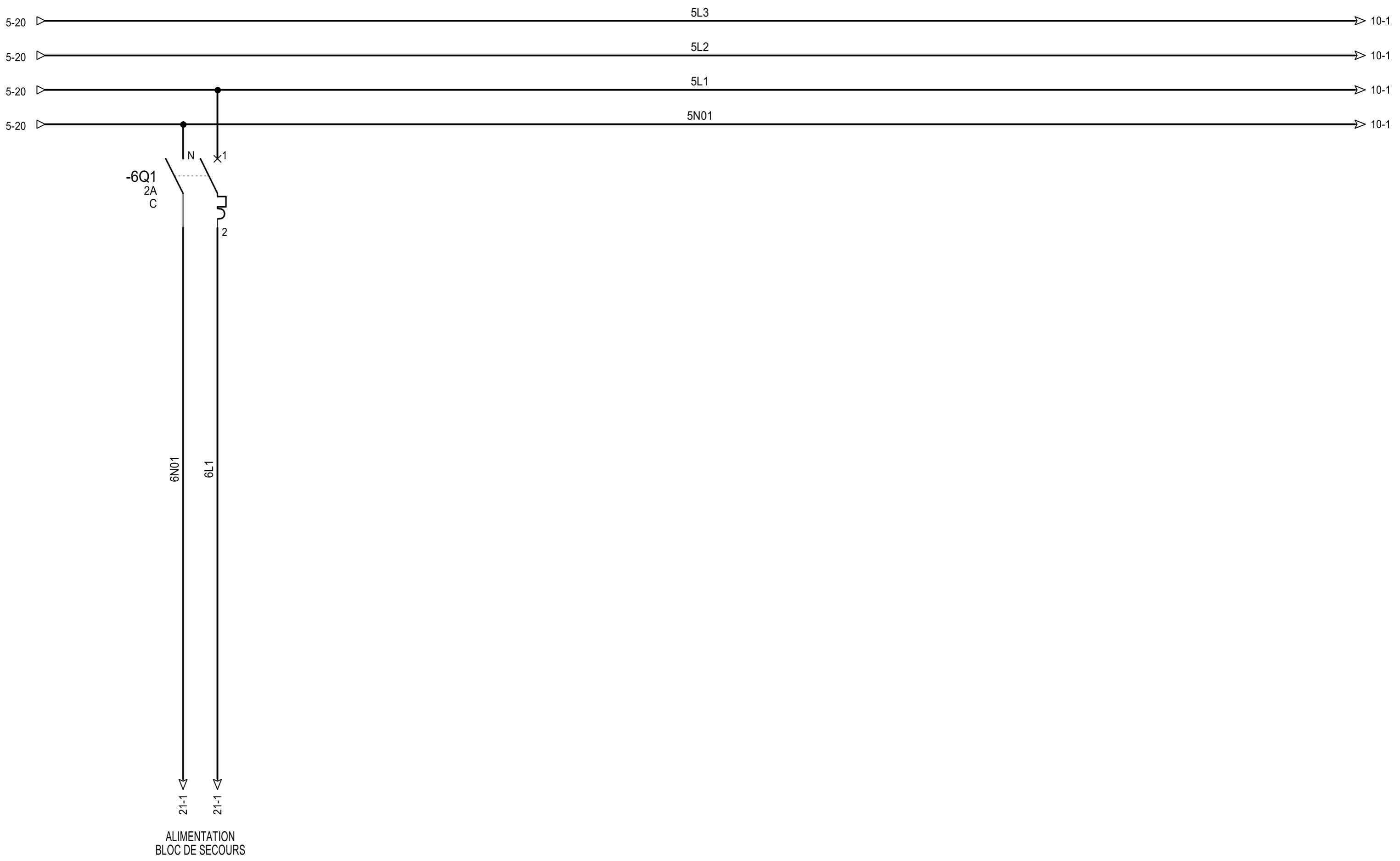

=
+ A1



DESSINE :	G. BOUCHUT				
VERIFIE :	L. CHRISTOPHLE				
DATE DE CREATION :	01/10/2019	A	08/10/2019	CEID - Première diffusion	GB
		INDICE	DATE	MODIFICATION	DES.

SADE
Document n° : **7200-010**

BATIMENT UFT
Alimentation bloc de secours

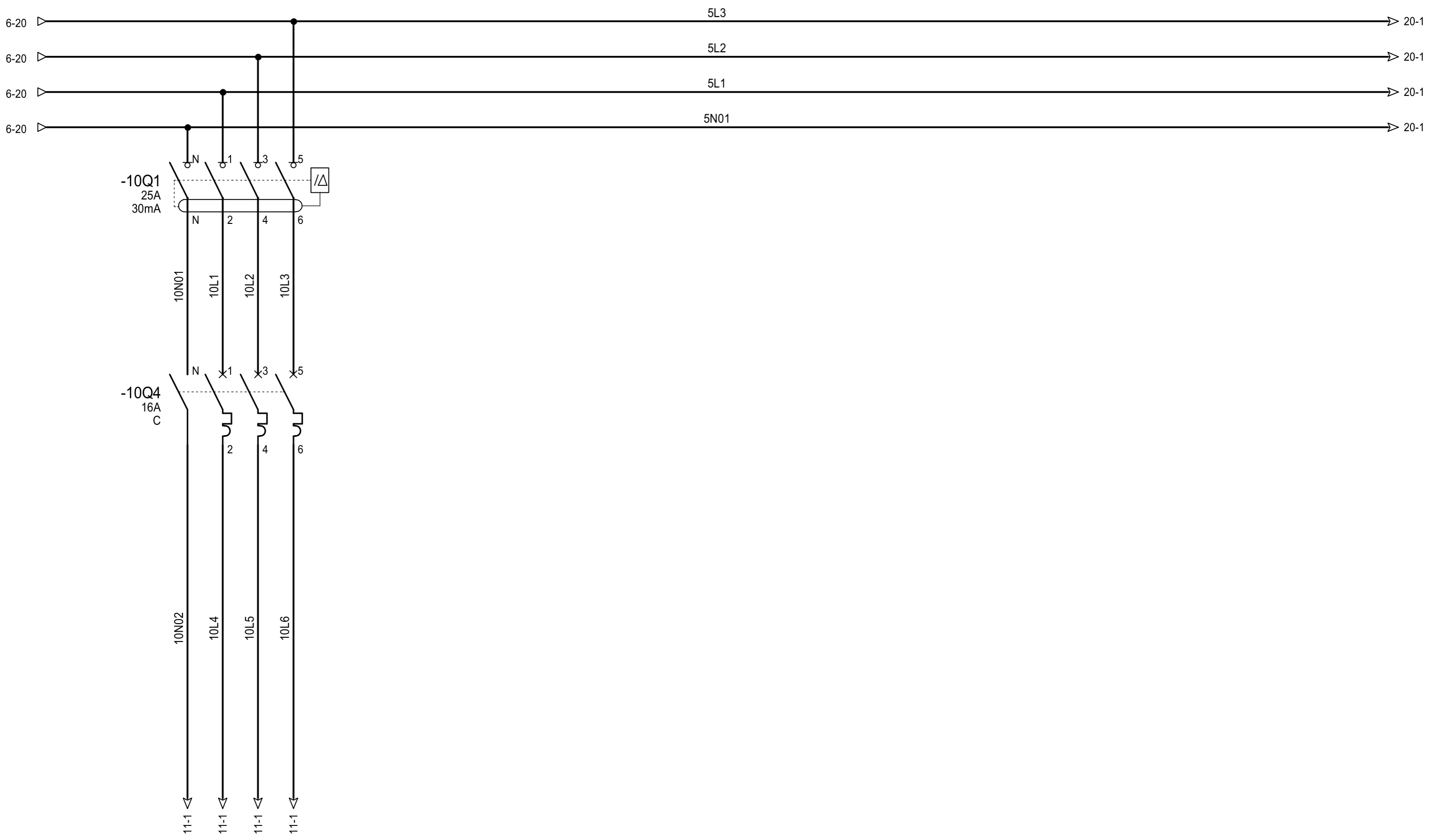

ALIMENTATION
COFFRET DE PRISES

=
+ A1

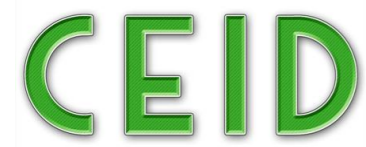

DESSINE :	G. BOUCHUT			
VERIFIE :	L. CHRISTOPHLE			
DATE DE CREATION :	01/10/2019	A	08/10/2019	CEID - Première diffusion
INDICE	DATE	MODIFICATION		DES.

SADE	
Document n° : 7200-010	

BATIMENT UFT Départs prises de courant

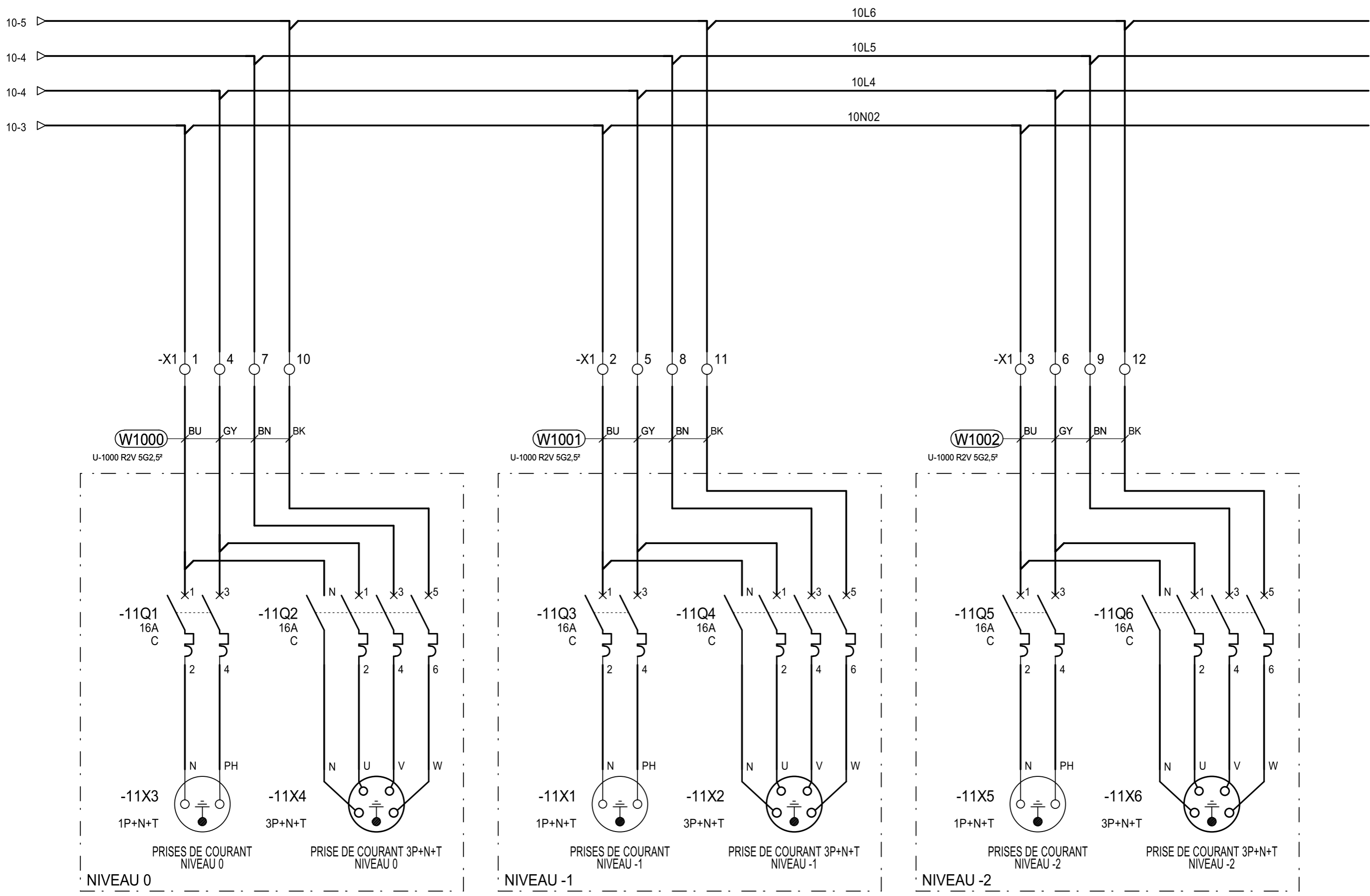

+ A1



DESSINE :	G. BOUCHUT			
VERIFIE :	L. CHRISTOPHLE			
DATE DE CREATION :	01/10/2019	A	08/10/2019	CEID - Première diffusion
INDICE	DATE	MODIFICATION	DES.	

SADE
Document n° : 7200-010

BATIMENT UFT
Distribution prises de courant

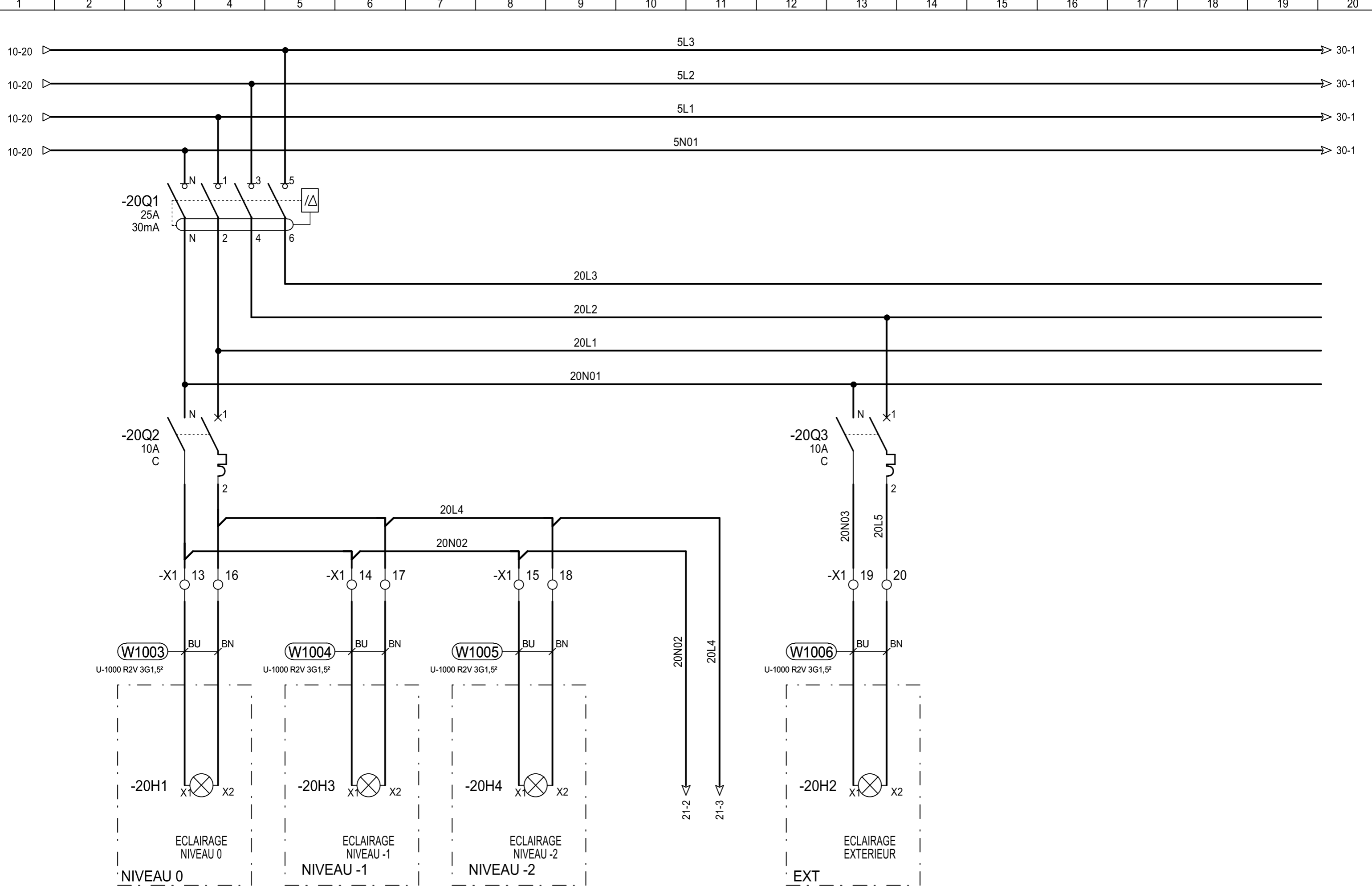

+ A1

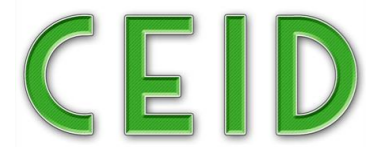

DESSINE :	G. BOUCHUT			
VERIFIE :	L. CHRISTOPHLE			
DATE DE CREATION :	01/10/2019	A	08/10/2019	CEID - Première diffusion
INDICE	DATE	MODIFICATION		DES.

SADE	
Document n° : 7200-010	

BATIMENT UFT
Départs éclairages

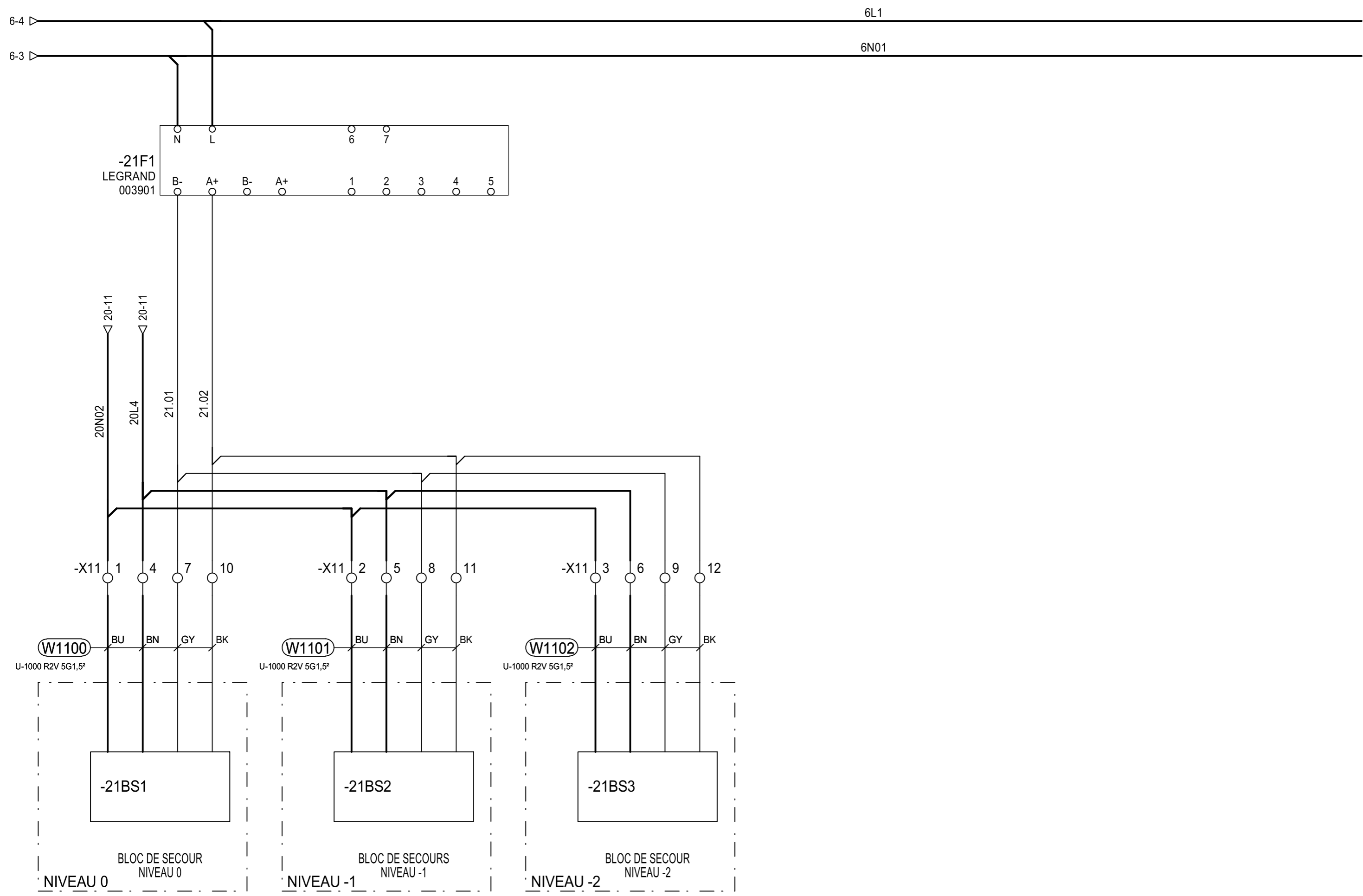

=
+ A1

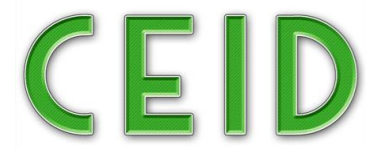

DESSINE :	G. BOUCHUT			
VERIFIE :	L. CHRISTOPHLE			
DATE DE CREATION :	01/10/2019	A	08/10/2019	CEID - Première diffusion
INDICE	DATE		MODIFICATION	DES.

SADE	
Document n° : 7200-010	

BATIMENT UFT	
Distribution blocs de secours	

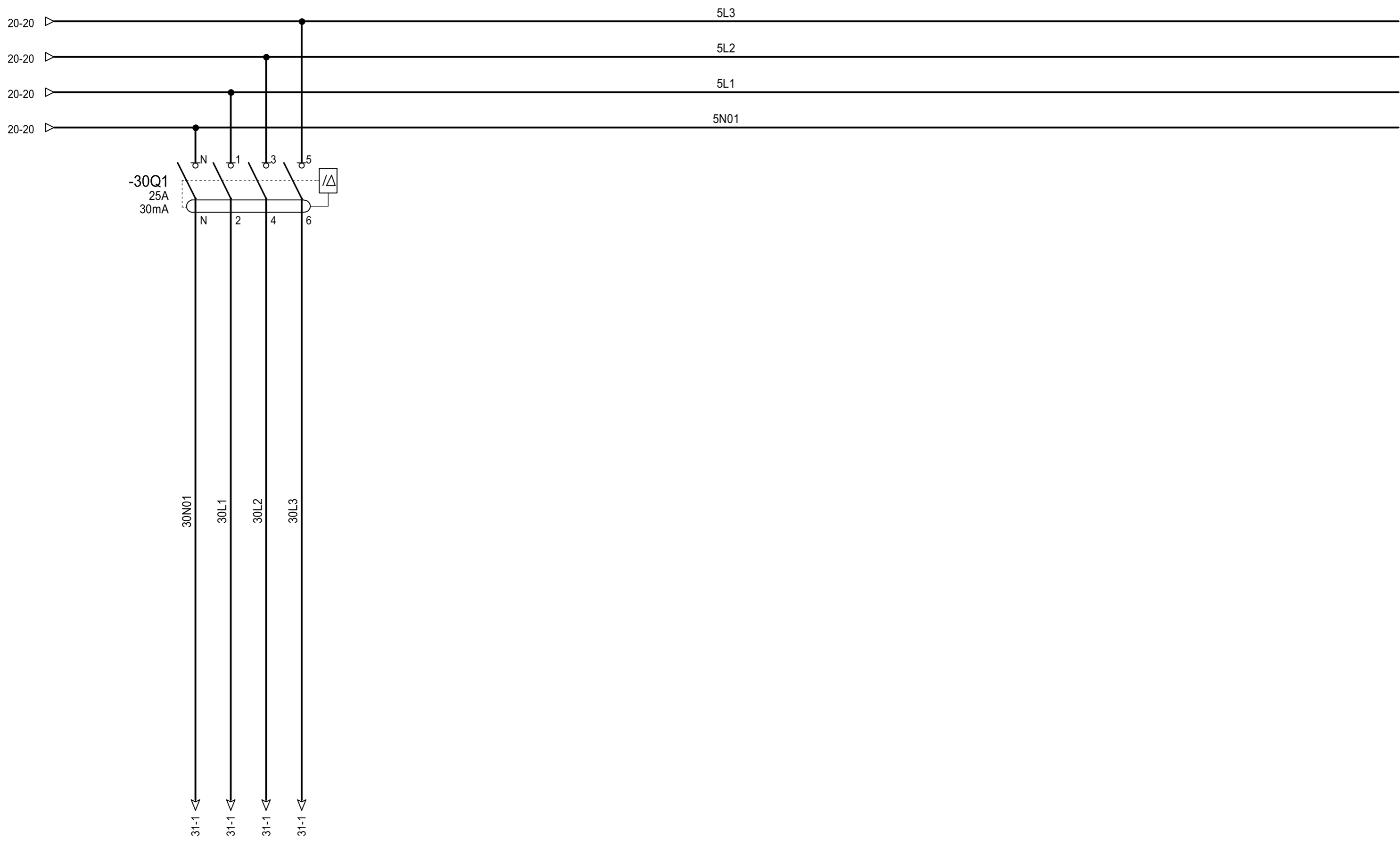

ALIMENTATION
DIVERS

=
+ A1



DESSINE :	G. BOUCHUT			
VERIFIE :	L. CHRISTOPHLE			
DATE DE CREATION :	01/10/2019	A	08/10/2019	CEID - Première diffusion
INDICE	DATE	MODIFICATION		DES.

SADE	
Document n° : 7200-010	

BATIMENT UFT Départs divers

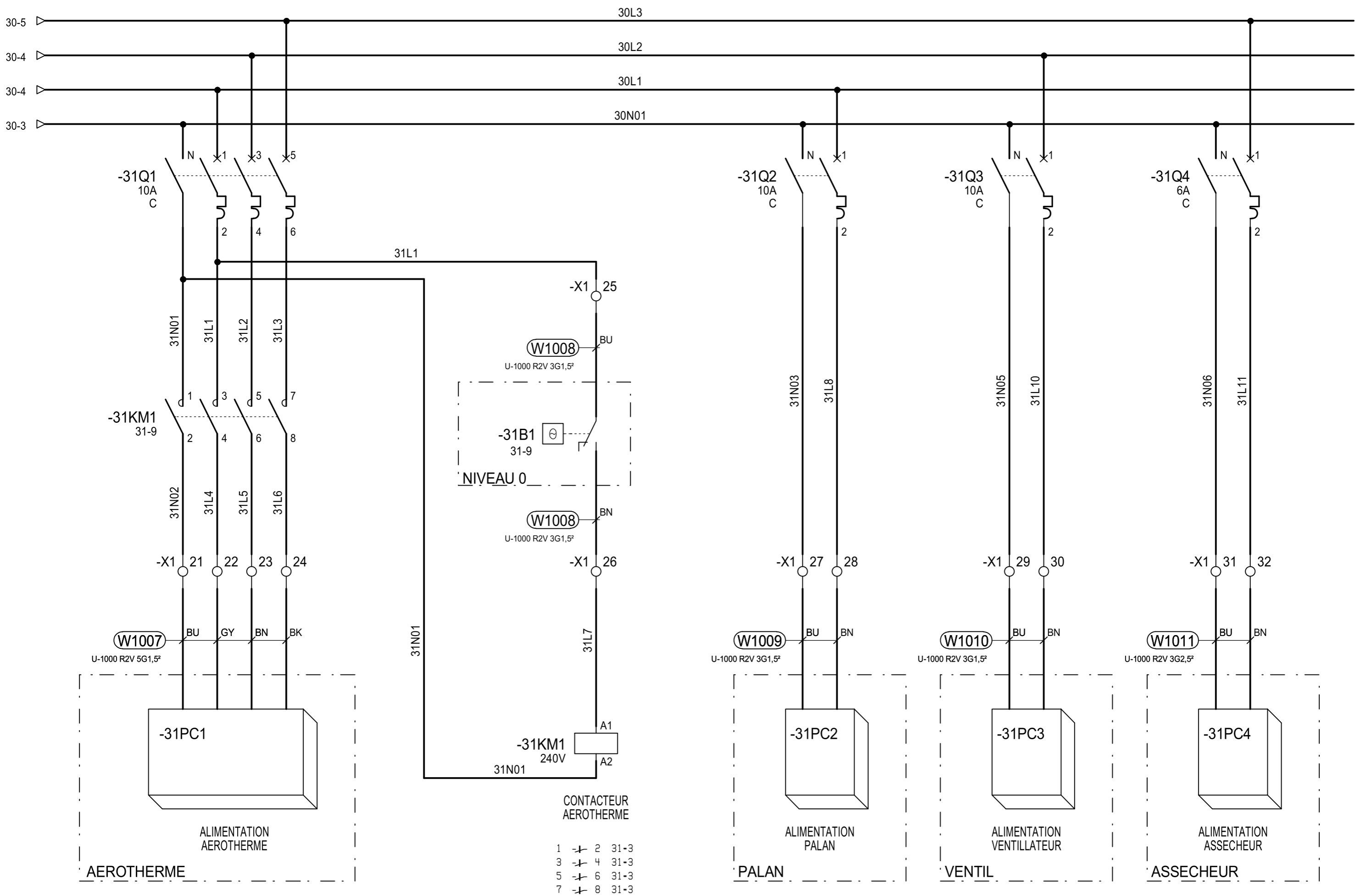

NIVEAU 0

- 1 - 2 31-3
- 3 - 4 31-3
- 5 - 6 31-3
- 7 - 8 31-3

+ A1



DESSINE :			
VERIFIE :	B	28/10/2019	CEID - Modification suivant remarques
DATE DE CREATION :	A	08/10/2019	CEID - Première diffusion
INDICE	DATE	MODIFICATION	DES.

SADE
Document n° : 7200-010

BATIMENT UFT
Départs divers

B	CEID - Modification suivant remarques	28/10/2019	GB	RC	
A	CEID - Première diffusion	08/10/2019	GB	LC	
INDICE	MODIFICATION	DATE	DESSINE	VERIFIE	APPROUVE



194 ZA DE REMOULON
38 780 PONT-EVEQUE

N° TEL: 04 74 57 68 87
N° FAX: 04 74 57 68 92
DESSINE: G.BOUCHUT
VERIFIE: L.CHRISTOPHLE
DATE DE CREATION: 01/10/2019
AFFAIRE N°: 7200

SADE

RUE PIERRE DUPONT
69 741 GENAS

BATIMENT UFT

Documents annexes

Page de garde

DOCUMENT N° : **7200-060**

1 / 8

N° FOLIO	DESIGNATION	MODIFICATIONS								
		A	B	C	D	E	F	G	H	I
1	Page de garde	A								
2	Liste des folios	A	B							
3	Liste du matériel	A	B							
4	Nomenclature matériel	A	B							
5	Liste des câbles : ALIM à W1102	A	B							
6	Bornier : +A1-Xp 1/1	A								
7	Bornier : +A1-X1 1/1	A	B							
8	Bornier : +A1-X11 1/1	A								

N° FOLIO	DESIGNATION	MODIFICATIONS								
		A	B	C	D	E	F	G	H	I



DESSINE :	G.BOUCHUT				
VERIFIE :	L.CHRISTOPHLE	B	28/10/2019	CEID - Modification suivant remarques	GB
DATE DE CREATION :	01/10/2019	A	08/10/2019	CEID - Première diffusion	GB
INDICE	DATE	INDICE	DATE	MODIFICATION	DES.

SADE

Document n° : **7200-060**

BATIMENT UFT
Liste des folios

=
+

REFERENCE	FABRICANT	DESIGNATION	QTE
003901	LEGRAND	TELECOMMANDE LEXIC STANDARD NON POLARISE	1
004888	LEGRAND	REPARTITEUR MODULAIRE MONOBLOC TETRAPOLA	1
A9C20864	SCHNEIDER ELECTRIC	CONTACTEUR ICT TETRA 4NO 63A 220-240V 50	1
A9P22602	SCHNEIDER ELECTRIC	DISJONCTEUR iDT40 1P+N 2A 6kA COURBE C	1
A9P22606	SCHNEIDER ELECTRIC	DISJONCTEUR iDT40 1P+N 6A 6kA COURBE C	1
A9P22610	SCHNEIDER ELECTRIC	DISJONCTEUR iDT40 1P+N 10A 6kA COURBE C	4
A9P22616	SCHNEIDER ELECTRIC	DISJONCTEUR iDT40 1P+N 16A 6kA COURBE C	3
A9P22710	SCHNEIDER ELECTRIC	DISJONCTEUR iDT40 3P+N 10A 6kA COURBE C	1
A9P22716	SCHNEIDER ELECTRIC	DISJONCTEUR iDT40 3P+N 16A 6kA COURBE C	4
A9R11425	SCHNEIDER ELECTRIC	INTERRUPTEUR DIFFERENTIEL iID TYPE AC 41	3
VCF1	SCHNEIDER ELECTRIC	INTERRUPTEUR SECTIONNEUR PRINC.AU 32A	1
VZ1	SCHNEIDER ELECTRIC	POLE PRINCIPAL 32A	1

REFERENCE	FABRICANT	DESIGNATION	QTE

=
+



DESSINE :	G. BOUCHUT			
VERIFIE :	B	28/10/2019	CEID - Modification suivant remarques	GB
DATE DE CREATION :	A	08/10/2019	CEID - Première diffusion	GB
01/10/2019	INDICE	DATE	MODIFICATION	DES.

SADE
Document n° : 7200-060

BATIMENT UFT Liste du matériel

REPERE	FOLIO	DESIGNATION	REFERENCE	FABRICANT	QTE
10Q1	10	INTERRUPTEUR DIFFERENTIEL IID TYPE AC 415VAC 4P 25A 30mA	A9R11425	SCHNEIDER ELECTRIC	1
10Q4	10	DISJONCTEUR iDT40 3P+N 16A 6kA COURBE C	A9P22716	SCHNEIDER ELECTRIC	1
11Q1	11	DISJONCTEUR iDT40 1P+N 16A 6kA COURBE C	A9P22616	SCHNEIDER ELECTRIC	1
11Q2	11	DISJONCTEUR iDT40 3P+N 16A 6kA COURBE C	A9P22716	SCHNEIDER ELECTRIC	1
11Q3	11	DISJONCTEUR iDT40 1P+N 16A 6kA COURBE C	A9P22616	SCHNEIDER ELECTRIC	1
11Q4	11	DISJONCTEUR iDT40 3P+N 16A 6kA COURBE C	A9P22716	SCHNEIDER ELECTRIC	1
11Q5	11	DISJONCTEUR iDT40 1P+N 16A 6kA COURBE C	A9P22616	SCHNEIDER ELECTRIC	1
11Q6	11	DISJONCTEUR iDT40 3P+N 16A 6kA COURBE C	A9P22716	SCHNEIDER ELECTRIC	1
20Q1	20	INTERRUPTEUR DIFFERENTIEL IID TYPE AC 415VAC 4P 25A 30mA	A9R11425	SCHNEIDER ELECTRIC	1
20Q2	20	DISJONCTEUR iDT40 1P+N 10A 6kA COURBE C	A9P22610	SCHNEIDER ELECTRIC	1
20Q3	20	DISJONCTEUR iDT40 1P+N 10A 6kA COURBE C	A9P22610	SCHNEIDER ELECTRIC	1
21F1	21	TELECOMMANDE LEXIC STANDARD NON POLARISEE, JUSQUE 300 BLOCS, 4 MOD, ALIM. 2	003901	LEGRAND	1
30Q1	30	INTERRUPTEUR DIFFERENTIEL IID TYPE AC 415VAC 4P 25A 30mA	A9R11425	SCHNEIDER ELECTRIC	1
31KM1	31	CONTACTEUR iCT TETRA 4NO 63A 220-240V 50Hz	A9C20864	SCHNEIDER ELECTRIC	1
31Q1	31	DISJONCTEUR iDT40 3P+N 10A 6kA COURBE C	A9P22710	SCHNEIDER ELECTRIC	1
31Q2	31	DISJONCTEUR iDT40 1P+N 10A 6kA COURBE C	A9P22610	SCHNEIDER ELECTRIC	1
31Q3	31	DISJONCTEUR iDT40 1P+N 10A 6kA COURBE C	A9P22610	SCHNEIDER ELECTRIC	1
31Q4	31	DISJONCTEUR iDT40 1P+N 6A 6kA COURBE C	A9P22606	SCHNEIDER ELECTRIC	1
5Q1	5	INTERRUPTEUR SECTIONNEUR PRINC.AU 32A	VCF1	SCHNEIDER ELECTRIC	1
5Q1	5	POLE PRINCIPAL 32A	VZ1	SCHNEIDER ELECTRIC	1
5REP1	5	REPARTITEUR MODULAIRE MONOBLOC TETRAPOLAIRE, 125A, 2x25, 2x16+11x6	004888	LEGRAND	1
6Q1	6	DISJONCTEUR iDT40 1P+N 2A 6kA COURBE C	A9P22602	SCHNEIDER ELECTRIC	1



DESSINE :	G. BOUCHUT				
VERIFIE :		B	28/10/2019	CEID - Modification suivant remarques	GB
DATE DE CREATION :	01/10/2019	A	08/10/2019	CEID - Première diffusion	GB
		INDICE	DATE	MODIFICATION	DES.

SADE

Document n° : **7200-060**

BATIMENT UFT
Nomenclature matériel

REPERE	TYPE/SECTION	TENANT	ABOUTISSANT	OBSERVATIONS	OBSERVATIONS
ALIM	U-1000 R2V 5G6 ²	A1	ALIMENTATION		CABLE RIGIDE
W1000	U-1000 R2V 5G2,5 ²	A1	NIVEAU 0		CABLE RIGIDE
W1001	U-1000 R2V 5G2,5 ²	A1	NIVEAU -1		CABLE RIGIDE
W1002	U-1000 R2V 5G2,5 ²	A1	NIVEAU -2		CABLE RIGIDE
W1003	U-1000 R2V 3G1,5 ²	A1	NIVEAU 0		CABLE RIGIDE
W1004	U-1000 R2V 3G1,5 ²	A1	NIVEAU -1		CABLE RIGIDE
W1005	U-1000 R2V 3G1,5 ²	A1	NIVEAU -2		CABLE RIGIDE
W1006	U-1000 R2V 3G1,5 ²	A1	EXT		CABLE RIGIDE
W1007	U-1000 R2V 5G1,5 ²	A1	AEROTHERME		CABLE RIGIDE
W1008	U-1000 R2V 3G1,5 ²	A1	NIVEAU 0		CABLE RIGIDE
W1009	U-1000 R2V 3G1,5 ²	A1	PALAN		CABLE RIGIDE
W1010	U-1000 R2V 3G1,5 ²	A1	VENTIL		CABLE RIGIDE
W1011	U-1000 R2V 3G2,5 ²	A1	ASSECHEUR		CABLE RIGIDE
W1100	U-1000 R2V 5G1,5 ²	A1	NIVEAU 0		CABLE RIGIDE
W1101	U-1000 R2V 5G1,5 ²	A1	NIVEAU -1		CABLE RIGIDE
W1102	U-1000 R2V 5G1,5 ²	A1	NIVEAU -2		CABLE RIGIDE

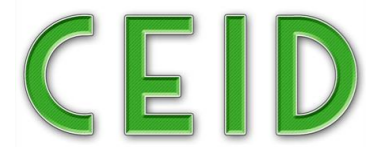

DESSINE :				
VERIFIE :	B	28/10/2019	CEID - Modification suivant remarques	GB
DATE DE CREATION :	A	08/10/2019	CEID - Première diffusion	GB
01/10/2019	INDICE	DATE	MODIFICATION	DES.

SADE
 Document n° : **7200-060**

BATIMENT UFT
 Liste des câbles : ALIM à W1102

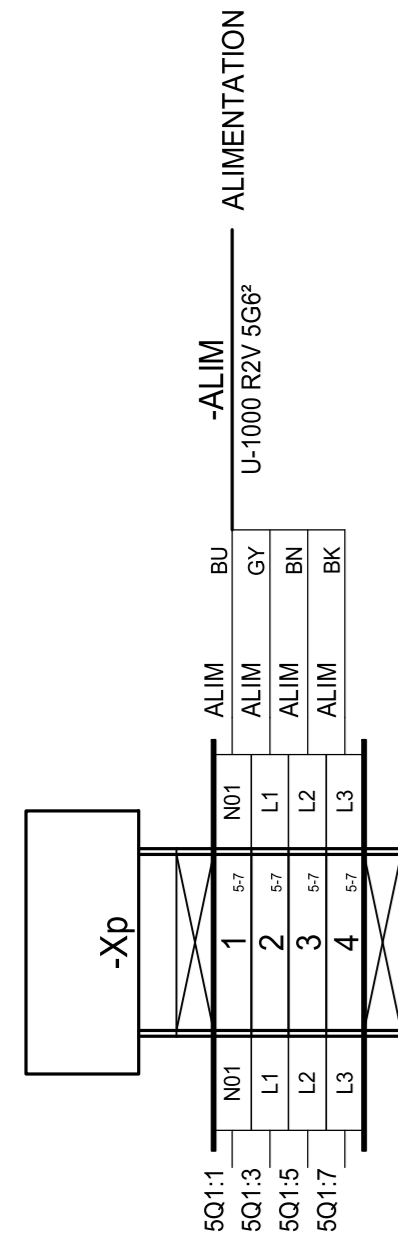

=
+ A1

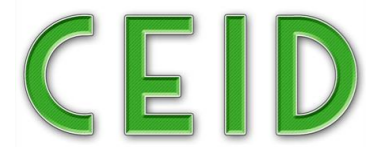

DESSINE :	G. BOUCHUT				
VERIFIE :					
DATE DE CREATION :	01/10/2019	A	08/10/2019	CEID - Première diffusion	GB
		INDICE	DATE	MODIFICATION	DES.

SADE
Document n° : 7200-060

BATIMENT UFT Bornier : +A1-Xp 1/1
--

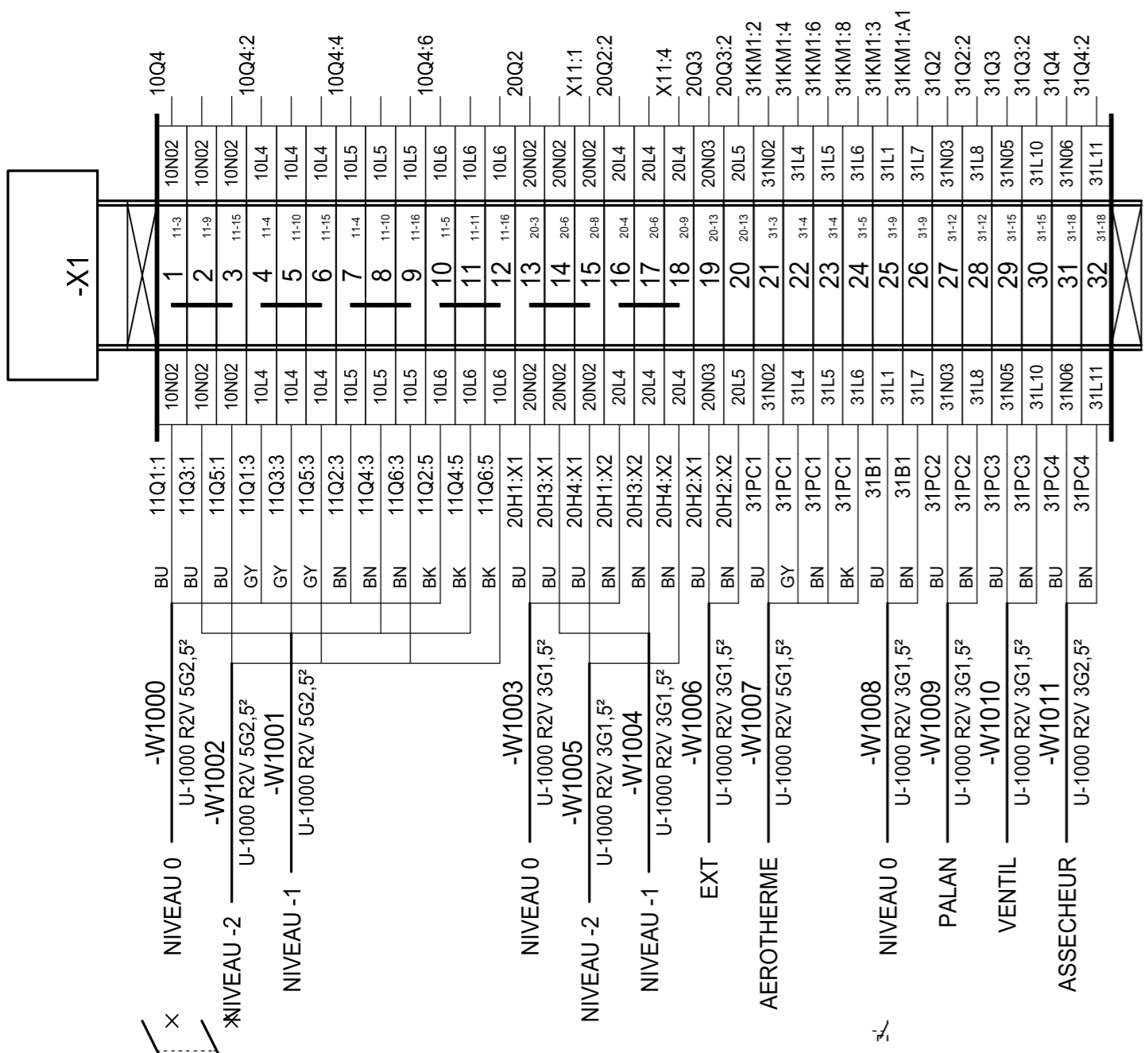

=
+ A1



DESSINE :	G. BOUCHUT		
VERIFIE :	B	28/10/2019	CEID - Modification suivant remarques
DATE DE CREATION :	A	08/10/2019	CEID - Première diffusion
01/10/2019	INDICE	DATE	MODIFICATION
			DES.

SADE	
Document n° : 7200-060	

BATIMENT UFT
Bornier : +A1-X1
1/1

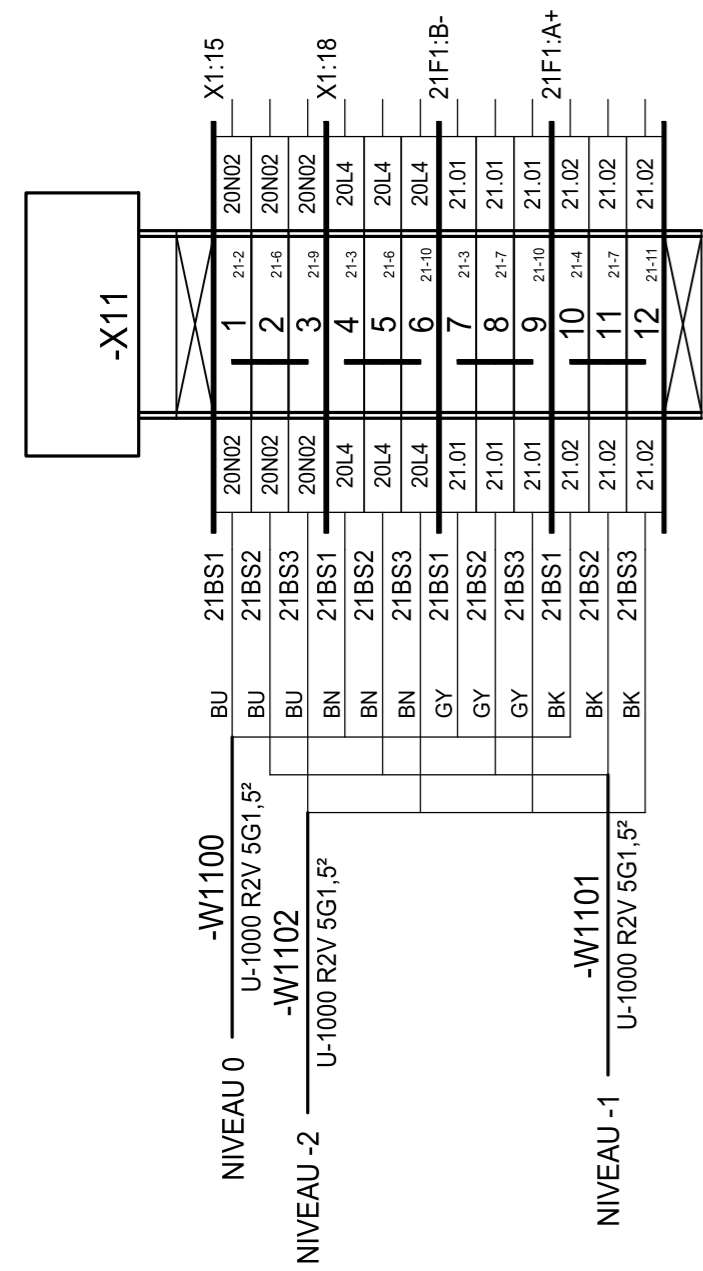

=
+ A1



DESSINE :	G. BOUCHUT				
VERIFIE :					
DATE DE CREATION :	A 08/10/2019	CEID - Première diffusion	GB		
	01/10/2019	INDICE	DATE	MODIFICATION	DES.

SADE	
Document n° : 7200-060	

BATIMENT UFT Bornier : +A1-X11 1/1

FOLIO 8 ◀ 7 ▶ Logiciel SEE v. 4.40
--